

# Toggle Switch Boots

HEXSEAL® and E-SEEL® toggle switch boots are molded from a high tear-strength silicone rubber (other materials available for specific environments) bonded to a built-in mounting nut. Each encloses the base of the protruding switch bushing and forms a watertight and dust-tight seal against the front panel surface.

## SPECIFICATIONS

<b>Material</b> .....	HEXSEALS: Silicone rubber conforms to A-A-59588, Class 3B, GR 50 (unless otherwise specified). E-SEELS: Silicone rubber polymer type ASTM D 1418
<b>Mounting Nut</b> .....	HEXSEALS: Brass, nickel-plated E-SEELS: Brass, black-oxide
<b>Temperature Range</b> .....	HEXSEALS: -94°F to +400°F (-70°C to +204°C) E-SEELS: -80°F to +400°F (-62°C to +204°C)
<b>Enclosure Protection</b> .....	NEMA/UL/ULC Types 1, 2, 3, 3S, 3R, 4, 4X, 6P, 12, 13; IEC IP66/IP68
<b>Pressure Range</b> .....	Exceeds 15 psi internal and 1500 psi external (N5032B: 10 psi)
<b>Operational Life</b> .....	100,000 actuations (minimum)
<b>Shelf Life</b> .....	Excess of 25 years
<b>Resistant to</b> .....	Salt spray, sunlight, ozone, weather, fungus, and most acids and lubricating oils
<b>Military Specs*</b> .....	Most HEXSEALS meet MIL-DTL-5423. (See listing on page 6)
<b>Agency Recognition</b> .....	UL & ULC Recognized Component to UL Std. 50
<b>Installation</b> .....	Please see installation instructions on page 19

\*APM's policy is to manufacture our HEXSEAL® sealing boots as defined by the requirements of MIL-Spec MIL-DTL-5423 which we regard as the standard for the switch, circuit breaker and potentiometer industry. These requirements were formulated based on our original patent.

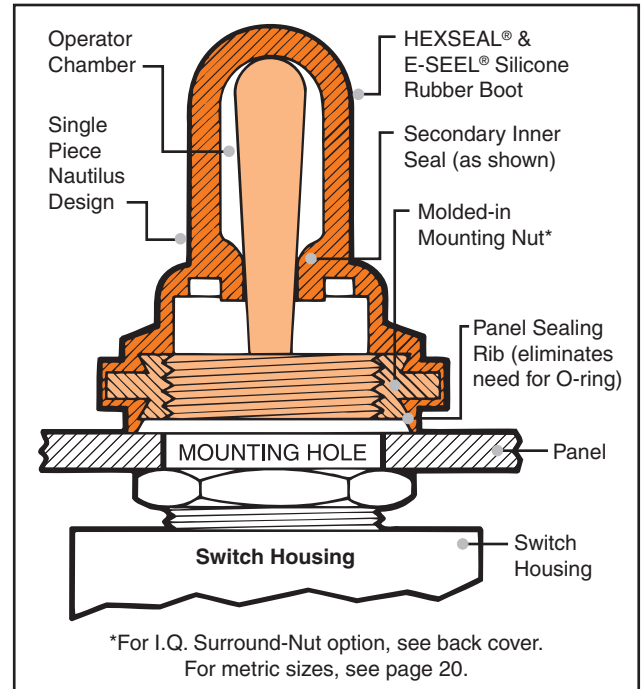

## HOW TO ORDER

Specify APM boot part number and, if necessary, the appropriate bushing adaptor part number (please see page 19).



**FIGURE 1 Full-Toggle Boot with Integral Secondary Inner Seal – IP66/68 Rated** Figure 1

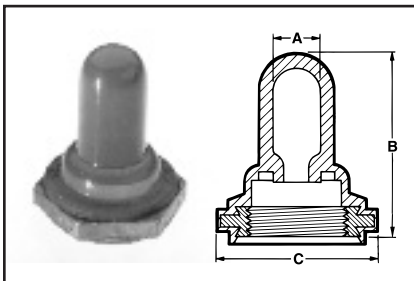

Thread Size	Max. Toggle Height Above Bushing (in.)	A Throat or I.D.		B Height		C Flat		Military Part Number	APM Boot Part Number	Color*	HEXSEAL	E-SEEL
		in.	mm	in.	mm	in.	mm					
1/4-40NS-2B	.31	.104	2.64	.422	10.72	.375	9.58	M5423/04-01	N-5030	Gray	•	
1/4-40NS-2B	.37	.062	1.53	.500	12.70	.375	9.52	M5423/05-01	N-5030L†	Gray	•	
1/4-40NS-2B	.28	.062	1.58	.390	9.91	.375	9.52	M5423/05-02	N-5030R	Gray	•	
1/4-40NS-2B	.50	.062	1.58	.594	15.08	.375	9.52	—	N-5030S	Gray	•	
1 9/32-32NS-2B	.66	.219	5.55	.844	21.44	.625	15.88	M5423/01-01	N-1030	Gray	•	
1/2-32NS-2B	.66	.219	5.55	.844	21.44	.625	15.88	—	N-1030 1/2-32	Gray	•	
1 9/32-32NS-2B	.71	.219	5.55	.937	23.81	.625	15.88	—	C1131/27	Black		•

\*Other colors available. Please consult factory. †Material conforms to A-A-59588 Gr. 25

**FIGURE 2 Full-Toggle Boots (with constant I.D.) – IP66/68 Rated** Figure 2

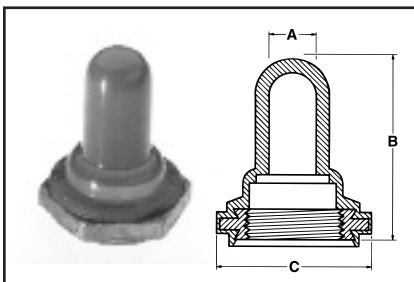

Thread Size	Max. Toggle Height Above Bushing (in.)	A Throat or I.D.		B Height		C Flat		Military Part Number	APM Boot Part Number	Color*	HEXSEAL	E-SEEL
		in.	mm	in.	mm	in.	mm					
M6 x 0.75	.37	.116	2.95	.562	14.30	.352	9.00	—	1131/25	Black	•	
1 5/32-32NS-2B	.437	.210	5.35	.625	15.88	.625	15.88	—	1131/33	Gray	•	
M12 x 1	.668	.234	5.95	.859	21.83	.625	15.88	—	1131/40	Black	•	
1 5/32-32NS-2B	.66	.219	5.55	.844	21.44	.625	15.88	—	IN-1030	Gray	•	
1 5/32-32NS-2B	.66	.256	6.50	.844	21.44	.625	15.88	—	1131/31	Gray	•	
1 5/32-32NS-2B	.90	.219	5.55	1.093	27.77	.625	15.88	—	1131/26	Gray	•	
1 5/32-32NS-2B	1.08	.390	9.92	1.328	33.37	.625	15.88	—	N-1002	Gray	•	
1 5/32-32NS-2B	.925	.300	7.62	1.110	28.19	.625	15.88	—	50154	Gray	•	
1/2-32NS-2B	.66	.219	5.55	.844	21.44	.625	15.88	—	IN-1030 1/2-32	Gray	•	
1/2-32NS-2B	.66	.256	6.50	.844	21.44	.625	15.88	—	1131/32	Black	•	
5/8-32UNS-2B	.78	.187	4.76	.844	21.44	.750	19.05	—	1131/23	Gray	•	
1 5/32-32NS-2B	.71	.219	5.55	.937	23.80	.625	15.88	—	C1131/28	Black		•

\*Other colors available. Please consult factory. Mounting nut material: Aluminum

**FIGURE 3 Half-Toggle Boots (toggle actuator protrudes) – IP66/68 Rated** Figure 3

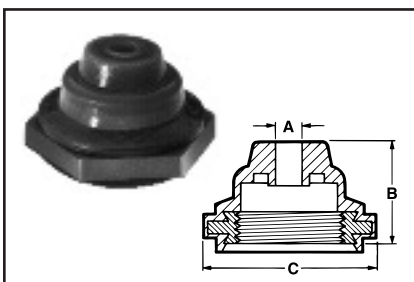

Thread Size	Toggle Diameter Accommodated (in.)	A Throat or I.D.		B Height		C Flat		Military Part Number	APM Boot Part Number	Color*	HEXSEAL	E-SEEL
		in.	mm	in.	mm	in.	mm					
1/4-40NS-2B	.062-.188	.047	1.19	.250	6.35	.375	9.53	M5423/11-01	N-5032B††	Gray	•	
1 5/32-32NS-2B	.115-.240	.109	2.77	.437	11.10	.625	15.88	M5423/02-01	N-1030B	Gray	•	
1/2-32NS-2B	.115-.240	.109	2.77	.437	11.10	.625	15.88	—	N-1030B 1/2-32	Gray	•	
1 5/32-32NS-2B	.115-.240	.109	2.77	.437	11.10	.625	15.88	—	C1132/20	Black		•

\*Other colors available. Please consult factory.

DIMENSIONS FOR REFERENCE ONLY. Current dimensional drawings can be viewed on our website and CAD drawings can also be downloaded.

FIGURE 4

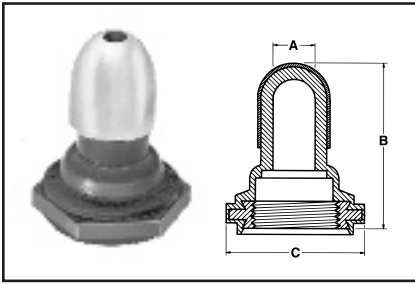

Armored Full Toggle Boots – IP66/68 Rated

Figure 4

Thread Size	Max. Toggle Height Above Bushing (in.)	A Throat or I.D.		B Height		C Flat		Military Part Number	APM Boot Part Number	Color	HEXSEAL	E-SEAL
		in.	mm	in.	mm	in.	mm					
1 5/32-32NS-2B	.66	.219	5.55	.875	21.44	.625	15.88	—	N-1030A	Gray	•	

Nickel plated brass cap bonded to boot.



FIGURE 5

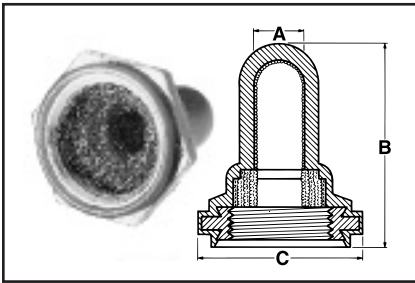

EMI/RFI Shielded Full Toggle Boots – IP66/68 Rated

Figure 5

Thread Size	Max. Toggle Height Above Bushing (in.)	A Throat or I.D.		B Height		C Flat		Military Part Number	APM Boot Part Number	Color*	HEXSEAL	E-SEAL
		in.	mm	in.	mm	in.	mm					
1/4-40NS-2B	.36	.062	1.58	.500	12.70	.375	9.52	—	N-5030L RFI	Gray	•	
1 5/32-32NS-2B	.66	.219	5.55	.844	21.44	.625	15.88	M5423/01-02	IN-1030 RFI	Gray	•	
1/2-32NS-2B	.66	.219	5.55	.844	21.44	.625	15.88	—	IN-1030 RFI 1/2-32	Gray	•	
1/4-40NS-2B	.28	.062	1.58	.390	9.90	.375	9.52	—	N-5030R RFI	Gray	•	
1/4-40NS-2B	.50	.062	1.58	.594	15.08	.375	9.52	—	N-5030S RFI	Gray	•	

\*Other colors available. Please consult factory.

All standard EMI/RFI boots feature a knitted Monel shield. RFI/EMI shielded boots have an operational life of 15,000 actuations (minimum)

FIGURE 5a



Sealed Switch Panel Cut-Out Sealing Bushing – IP66/68 Rated

Figure 5a

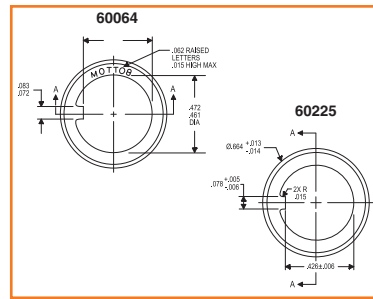

APM Part Number	Compatible Switch Bushing	Washer Diameter	Washer Thickness	Color	Conforms to*
60064	15/32-32	0.677"	0.120"	Gray	Meets MIL-B-5423/16-01, MS25196, UL & ULC Recognized Component
60225		0.660"	0.105"		

\*APM's policy is to manufacture our HEXSEAL® sealing boots as defined by the requirements of MIL-Spec MIL-DTL-5423 which we regard as the standard for the switch, circuit breaker and potentiometer industry. These requirements were formulated based on our original patent.

SEE PAGE 16 FOR FULL DETAILS

# Back-of-Panel Mounted Toggle Switch Boots

FIGURE 6

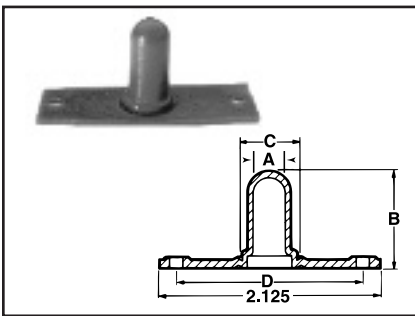

Full Toggle Boot

Figure 6

A Throat or I.D.		B Height		D Distance Between Mtg. Holes		Width		C Clearance Boot Hole Diameter		Military Part Number	APM Boot Part Number	Color*	HEXSEAL	E-SEAL
inch	mm	inch	mm	inch	mm	inch	mm	inch	mm					
.315	7.91	.938	23.82	1.813	46.04	.750	19.05	.510	12.95	—	2030	Gray	•	

\*Other colors available. Please consult factory.

FIGURE 7

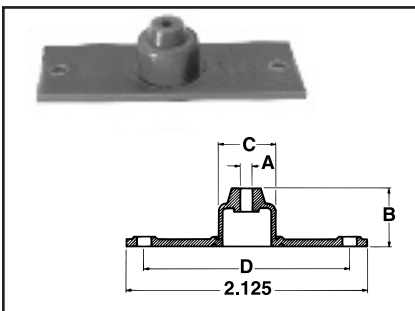

Half Toggle Boot (Toggle Actuator Protrudes)

Figure 7

A Throat or I.D.		B Height		D Distance Between Mtg. Holes		Width		C Clearance Boot Hole Diameter		Military Part Number	APM Boot Part Number	Color*	HEXSEAL	E-SEAL
inch	mm	inch	mm	inch	mm	inch	mm	inch	mm					
.093	2.38	.500	12.70	1.813	46.04	.750	19.05	.510	12.95	M5423/03-01	2030B	Gray	•	

\*Other colors available. Please consult factory.

DIMENSIONS FOR REFERENCE ONLY.

Current dimensional drawings can be viewed on our website and CAD drawings can also be downloaded.



# METRIC Sizes for Toggle, Pushbutton and Rotary Switches and Circuit Breakers

## SPECIFICATIONS

**Material**.....Silicone rubber polymer type ASTM D 1418  
**Mounting Nut**.....Brass, black-oxide. \*Brass, nickel-plated.  
**Temperature Range**....-80°F to +400°F (-62°C to +204°C)  
**Enclosure Protection**..NEMA/UL/ULC Types 1, 2, 3, 3S, 3R, 4, 4X, 6P, 12, 13; IEC IP66/IP68  
**Pressure Range**.....Exceeds 15 psi internal and 1500 psi external  
**Operational Life**.....100,000 actuations (minimum)  
**Shelf Life**.....Excess of 25 years  
**Resistant to**.....Salt spray, sunlight, ozone, weather, fungus, and most acids and lubricating oils  
**Agency Recognition**...UL & ULC Recognized Component to UL Std. 50  
**Installation**.....Please see installation instructions on page 19

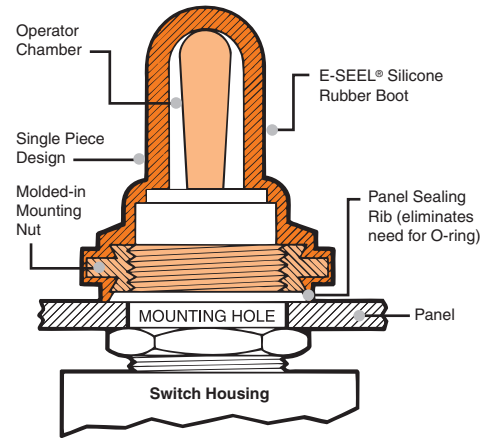

Additional metric sizes available (consult factory)

## TOGGLE SWITCH BOOTS

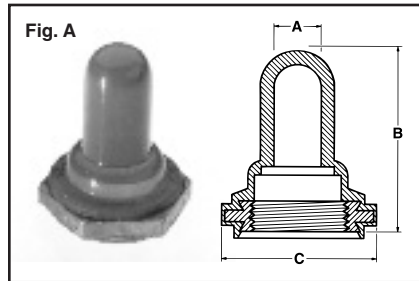

IP66/IP68/NEMA 6P Enclosure Protection

### Full Toggle (with Constant I.D.) Switch Boots (covers all external portions of switch & seals switch mounting hole)

Figure A

Thread Size	Throat Size <sup>1</sup> ("A")		Max Toggle Height <sup>2</sup>		Max Boot Height ("B")		Flat ("C")		Color	APM Cat. No.
	mm	in.	mm	in.	mm	in.	mm	in.		
M6 X 0.75	2.9	0.116	10.8	0.43	14.3	0.562	9.0	0.352	Black	1131/25*
M12 X 0.75	5.3	0.21	16.2	0.64	21.6	0.85	15.8	0.625	Black	C1131/41
M12 X 0.75	5.5	0.219	22.8	0.90	27.7	1.1	15.8	0.625	Black	1131/26-M12-.75
M12 X 1	6.5	0.256	16.7	0.66	21.4	0.844	15.8	0.625	Black	1131/31-M12
M12 X 1	5.9	0.234	16.9	0.66	21.8	0.859	15.8	0.625	Black	1131/40
M12 X 1	5.5	0.219	22.8	0.90	27.7	1.1	15.8	0.625	Black	1131/26-M12-.10

<sup>1</sup> Throat size is the maximum diameter of the switch toggle/handle (Dimension "A").

<sup>2</sup> Max toggle height is the maximum distance from the end of the switch mounting stem to the end of the switch toggle.

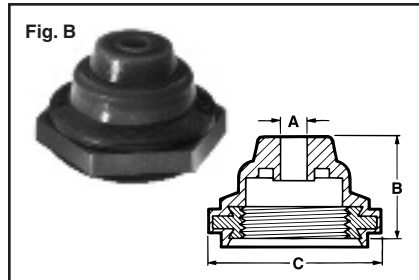

IP66/IP68/NEMA 6P Enclosure Protection

### Half Toggle Switch Boots (Seals switch mounting stem & hole; toggle actuator protrudes)

Figure B

Thread Size	Throat Size ("A")		Toggle Diameter Accomodated		Max Boot Height ("B")		Flat ("C")		Color	APM Cat. No.
	mm	in.	mm	in.	mm	in.	mm	in.		
M5 X 0.5	1.1	0.42	1.57-4.57	0.062-0.18	5.7	0.225/0.25	7.9	0.313	Black	1132/17-M5-5
M12 X 1	2.36	0.093	2.92-6.09	0.115-0.24	11.1	0.437	15.9	0.625	Black	1132/33-M12-1

## PUSHBUTTON SWITCHES & CIRCUIT BREAKERS/PROTECTORS

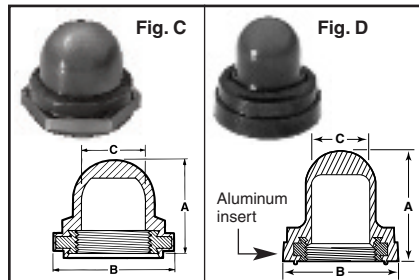

IP66/IP68/NEMA 6P Enclosure Protection

### Half Toggle Switch Boots (Seals switch mounting stem & hole; toggle actuator protrudes)

Figures C & D

Thread Size <sup>1</sup>	Max Boot Height ("A")		Max Plunger Height		Dimension "B"		Max Plunger Diameter ("C")		Color <sup>1</sup>	APM Cat. No.	Fig.
	mm	in.	mm	in.	mm	in.	mm	in.			
M10 X 1	15.47	0.62	8.4	0.33	16.3	0.64	8.1	0.32	Black	C1221/21	D
M11 X 1	15.47	0.62	11.9	0.469	18.3	0.72	10.72	0.422	Clear	C1221/27	D
M12 X 1	18.64	0.47	11.9	0.469	15.9	0.625	10.72	0.422	Black	NC3030H-M12-1	C

<sup>1</sup> "Clear" allows viewing of breaker amp rating and trip state; please enquire for other available colors.

## ROTARY SHAFT SEALS

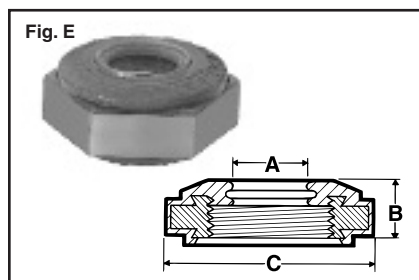

IP66/IP68/NEMA 6P Enclosure Protection

### Seal the shaft and mounting hole of standard rotary switches/potentiometers that use a threaded stem and nut mounting.

Figure E

Thread Size	Shaft Size <sup>1</sup> ("A")		Height ("B")		Flat ("C")		Color <sup>2</sup>	APM Cat. No.
	mm	in.	mm	in.	mm	in.		
M7 X 0.75	5.0	0.2	5.5	0.2	12.7	0.500	Gray	1332/39-2*
M9 X 0.75	6.35	0.250	5.56	0.219	12.7	0.500	Gray	C1332/41*
M10 X 1	6.0	0.236	5.9	0.236	12.7	0.500	Gray	1332/45*

<sup>1</sup> Switch/potentiometer shaft must have a smooth, round cross-section where it meets the sealing edge of the shaft seal device.

<sup>2</sup> Please enquire for other available colors.